

# Grensesnitt

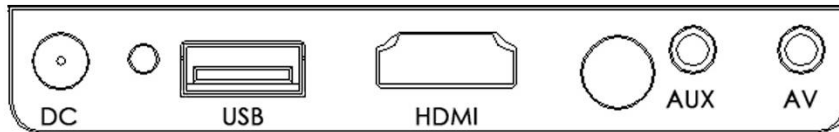

HDMI input slot  
(HDMI-inngangsspor)



USB input slot  
(USB-inngangsspor)



Earphone slot  
(Spor til øretelefon)



AV input slot  
(AV-inngangsspor)



DC power input  
(DC-strøminngang)



DC



Left  
(Venstre)



Right  
(Høyre)



OK



Input  
(Inngangseffekt)



Return  
(Tilbake)

# Introduksjon til fjernkontroll

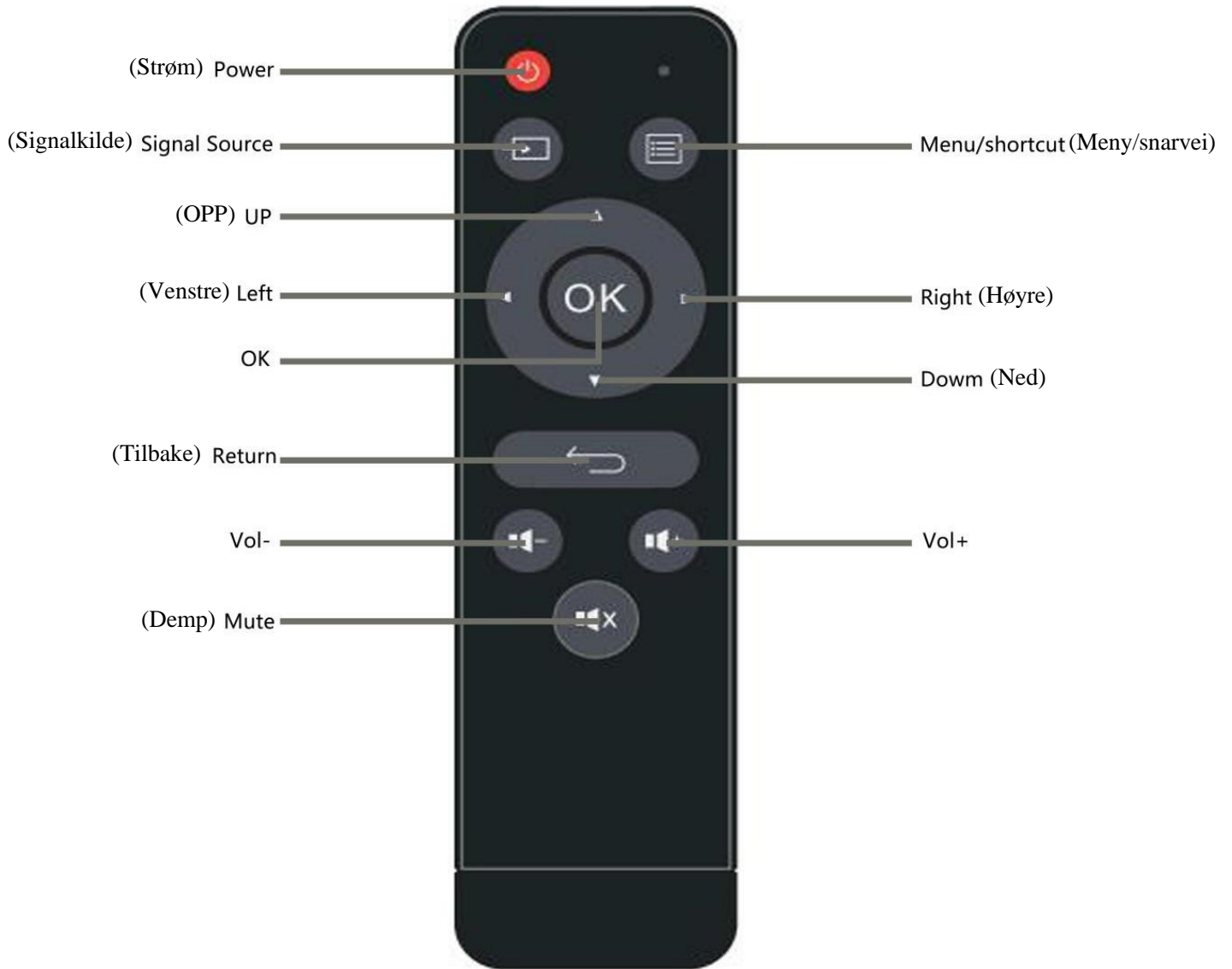

**\*MERK:**

1. For å unngå strømmangel, må du ikke blande gamle og nye batterier.
2. For å unngå korrosjon ved batterilekkasje, ta ut batteriene hvis fjernkontrollen ikke skal brukes på en stund.
3. Når du bruker fjernkontrollen, må du tilpasse fjernkontrollens signalsender til projektorens infrarøde signalmottaksvindu.

## Bruksanvisning

1. Koble til strømadapter (DC 15 V/3 A).

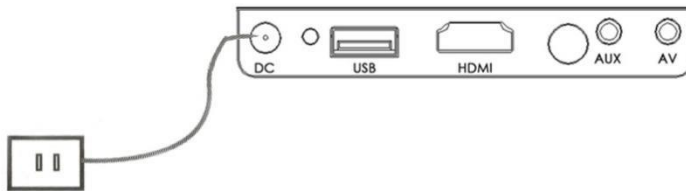

2. Slå på/slå av

Trykk på på/av-knappen på fjernkontrollen for å starte  projektoren.



### 3. Skjerm

Vent i 2 til 5 sekunder før du går inn på multimedieskjermen.



### 4. Fokus

Plasser projektoren vertikalt.

Juster objektivhjulet på venstre side av projektoren for å få et klart bilde

# Introduksjon til projektortilkobling

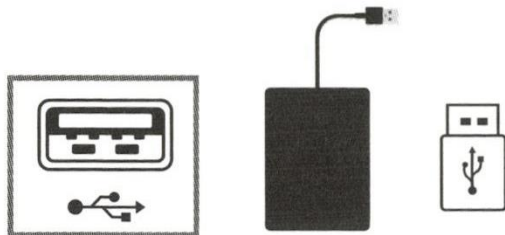
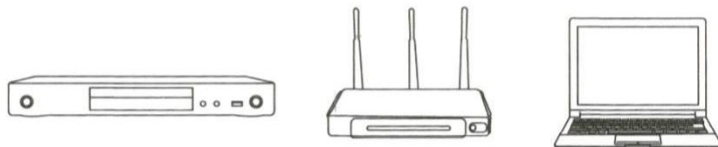
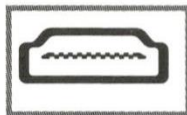
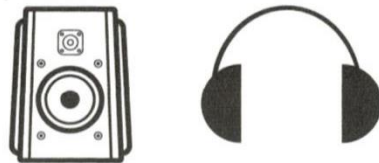
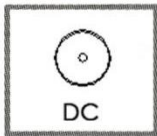
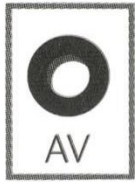

\* Du kan koble til flere enheter og applikasjoner.

## 2. Koble til flere medier

(1) Sett USB-kabelen inn i sporet (se bildet)

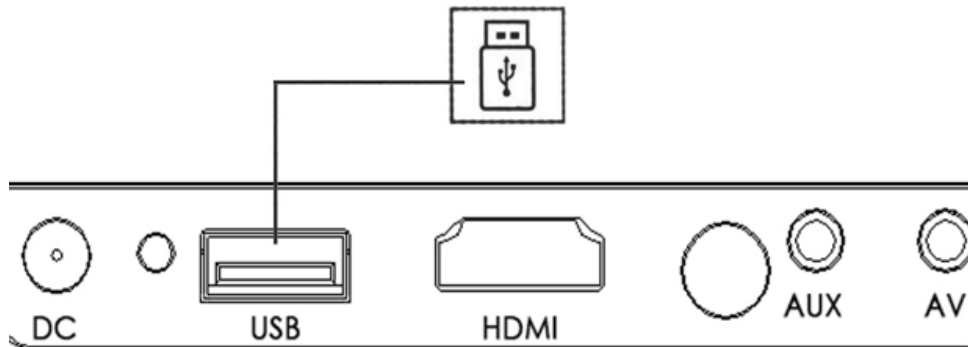

(2) Sett inn USB ved å koble til de relevante portene. Multimediestøttet format

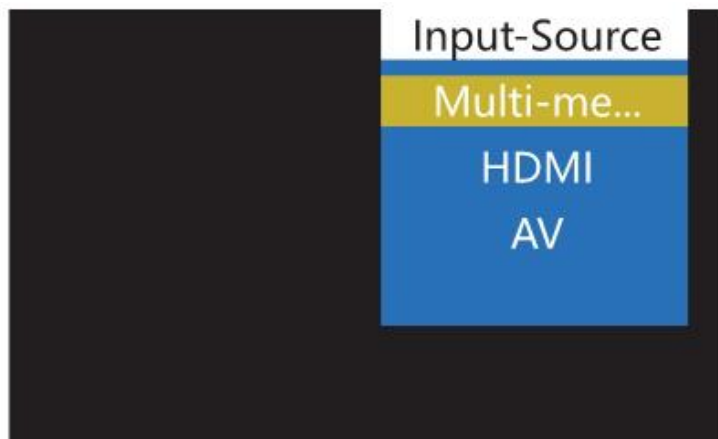

### Multimediestøttet format

Multi- medie	Lydstøtte	MP3,WMA,AAC,AC3,APE...
	Bildestøtte	JPG,JPEG,BMP,PNG
	Videostøtte	MPG,AV,TS,MOV,MKV,DAT,MP4,VOB /1080P Level
	Tekststøtte	TXT

(3) Velg hva du vil se: film, musikk, bilde eller tekst.

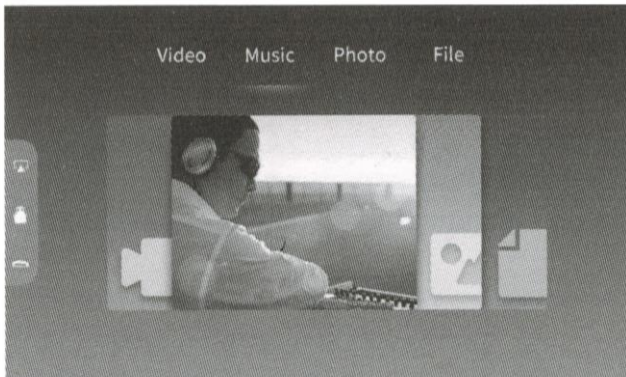

(4) Velg den filen du vil vise, trykk på

"▶||" "spill av / vis eller stopp."

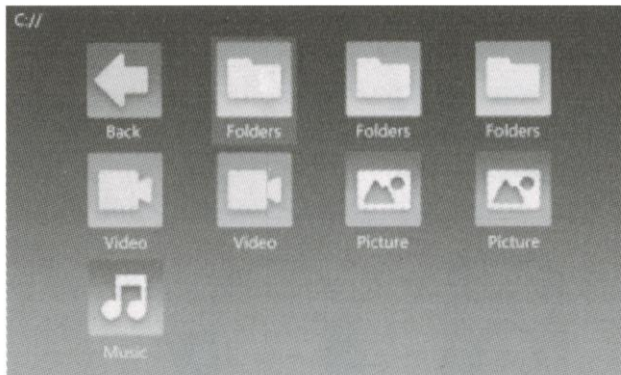

### 3. Koble til AV-vidеoutstyr

Bruk 3-i-1-kabel videokonverteringskabel, koble til projektor AV-spor, tilkoblingsmetode som på bildet nedenfor. Når projektoren og applikasjonen er koblet til, velg signalkildevideo.

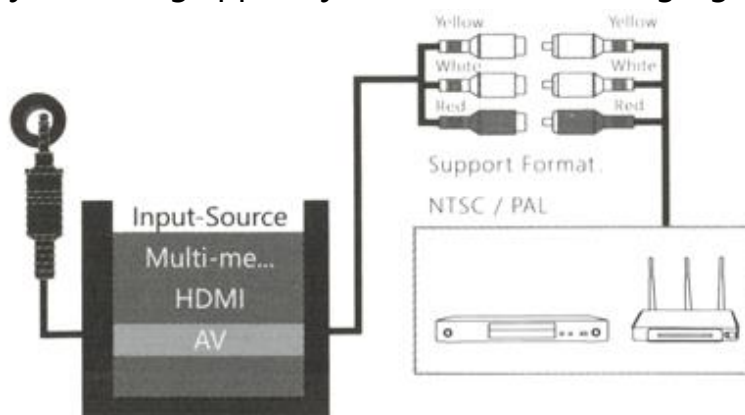

#### 4. Koble til HDMI-utstyr

HDMI-spor kan kobles til datamaskin eller enheter med HDMI-spor. Når du er tilkoblet, velger du signal HDMI.

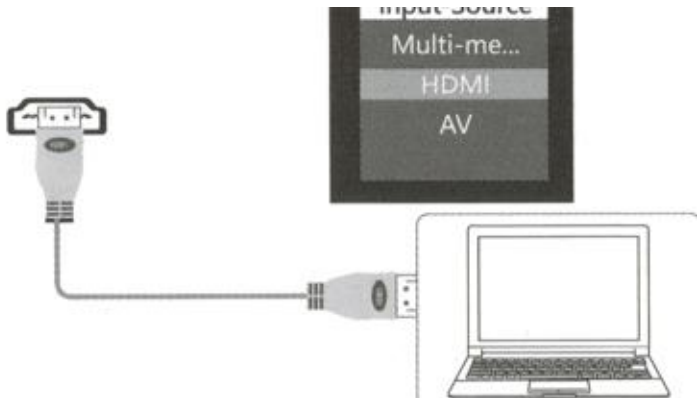

#### Støttefiler :

576P 480P 720P 1080P 640 \* 480 , 800 \* 600 1024 \* 768 1280 \* 1024  
1280 \* 720 , 1440 \* 900 , 1920 \* 1080 , 1366 \* 768 , 1280 \* 800 , 1440 \* 960  
1600 \* 1200 , 1680 \* 1050



#### 5. Koble til 3,5 mm lydenhet

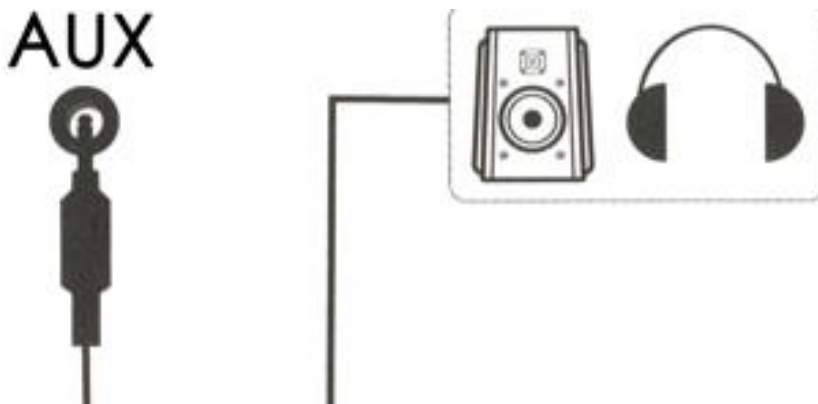

(1) Koble til 35 mm øretelefon og høyttaler





# Menyinnstillinger

1. Trykk på meny-tasten "  " på fjernkontrollen, og bruk Innstilling for å velge den rette funksjon. Du kan velge Bilde, Lyd, Tid eller Alternativ ved å bruke venstre og høyre knapp "  /  ".

Tryk på knappene "  /  " for å velge undermenyen og deretter på «OK» for å bekrefte meny-punktet.



## (1) Bildemodus

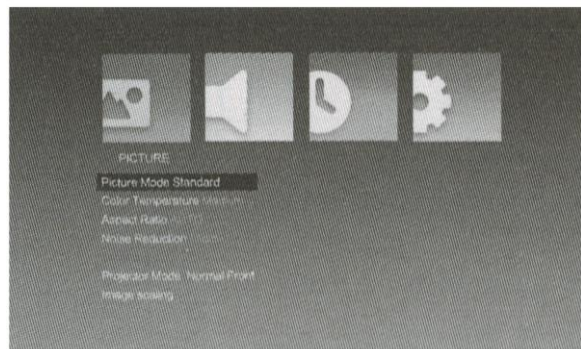

Du kan justere fargetemperatur, støyreduksjon, størrelsesforholdet, støyreduksjon, projeksjonsmodus, bilde Skalering



## (2) Lydmodus

Du kan justere Balanse, Automatisk volum, Surroundlyd

Trykk på menyen "  " og bruk "  /  " for menyvalg.

Bruk knappene "  /  " for å

velge undermenyen. Trykk på «OK» for å bekrefte meny-punktet.

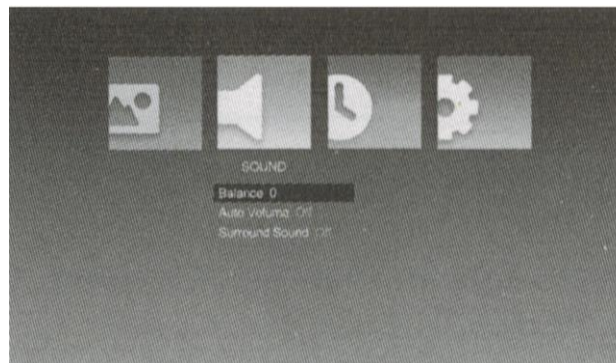

### (3) Tidsmodus



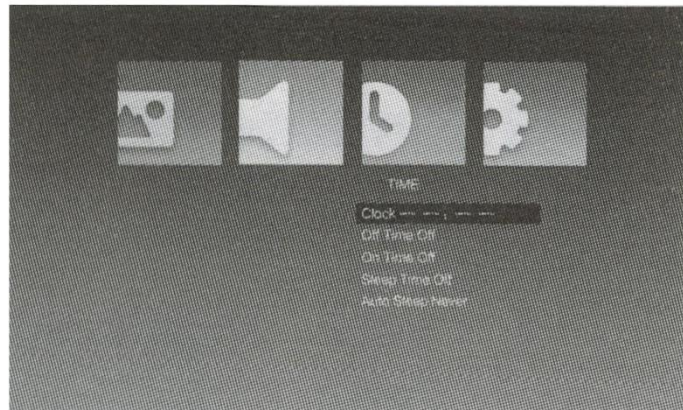

Du kan stille inn klokkeslett på/av, hvilemodus, automatisk hvilemodus.

Trykk på menyen "  " og bruk "  /  " for menyvalg. Bruk knappene

"  /  " for å velge undermenyen. Trykk på «OK» for å bekrefte menypunktet.



### (4) Alternativmodus

Du kan angi OSD-språk, tilbakestilling av fabrikk, projeksjonsmodus, OSD-varighet. Trykk på menyen "  " og bruk "  /  " for menyvalg. Bruk knappene "  /  " for å velge undermenyen. Trykk på «OK» for å bekrefte menypunktet.

## 2. Bruk av skjermmenyen

Du kan kontrollere innholdet ved hjelp av menyen bak MENU.



## Innebygd batteristrømforsyning (bare tilgjengelig for modeller med innebygd batteri)

Sett knappen under strømforsyningsporten til "på".

Nå lades projektoren av innebygd batteri. I

denne situasjonen vil projeksjonsstyrken være litt lavere.

Batterisymbolet på skjermen

viser gjenværende strøm.

\*Ladetid er ca. 3 timer.



## Spesifikasjoner

Bildeteknologi	TFT LCD
Oppløsning	1280*720P
Støtteløsning	1920*1080P
Lys	LED
Driftsmodus	Manuell drift
Projeksjonsavstand	1.5-2M
Projeksjonsforhold	1.6:1
Størrelsesforhold	16:9
Farge	16.7M
Strømforsyning	15V3A
Systemstøtte	Musikk, bilde, video, tekst